

Combination Automat **Polyquick 160-T95**

Pressure Polymerisation Automat and Compactor



USER MANUAL

Dear customer,

Thank you for choosing a product from the Wassermann range. Wassermann Dental-Maschinen incorporates the highest standards of quality and the latest technology. In order to enjoy maximum performance and years of trouble-free operation, please read this user manual carefully before you connect this unit and start work, and operate the unit according to the recommended guidelines. The operation safety and the functionality of this unit can only be guaranteed if you follow both the general safety guidelines and the applying laws to prevent accidents as well as the precautions given in this user manual. We are not liable for any damages which occur due to inappropriate usage or faulty operation of this unit.



Make sure that anyone using this unit has read and understood this user manual.

Keep this user manual in a safe place where it can be referred to as required at any time.

 The unit complies with the relevant EU guidelines.



The unit is subject to the EU guidelines 2012/19/EU (WEEE Directive).

Company address:

Wassermann Dental-Maschinen GmbH

Rudorffweg 15-17

21031 Hamburg, Germany

Phone : +49 (0)40 730 926 -20/ -24 Fax.: +49 (0)40 730 37 24

export@wassermann-dental.com

www.wassermann.hamburg

www.facebook.com/WassermannDentalmaschinen

Contents

1 Features.....	4
2 Safety Symbols used in this Manual.....	4
3 Safety Guidelines.....	5
4 Responsibility for Operation or Damage.....	6
5 Application.....	6
6 Before Starting.....	7
6.1 Transport.....	7
6.2 Installation.....	7
6.3 Storage.....	7
7 Installation/ Start-up.....	8
7.1 Setting the correct Pressure.....	9
7.2 Start-up.....	10
8 Operation.....	17
8.1 General Operating Instructions.....	17
8.2 Operation.....	18
9 Troubleshooting.....	19
10 Care and Maintenance.....	21
10.1 Cleaning.....	21
10.2 Maintenance.....	21
10.3 Repairs.....	21
10.4 Spare Parts.....	22
10.5 Service Hotline 0049 (0)40 / 730 926 -20/ -24.....	22
10.6 Scope of Delivery/ Accessories.....	22
10.7 Warranty.....	23
11 Technical Data.....	23
12 Disposing of the Unit.....	24
12.1 Information on Disposal for Countries within the EU.....	24
13 EU Declaration of Conformity.....	25

1 Features

- Compact table-top unit for pressure polymerisation up to 95 °C in a water bath
- Large capacity Ø 150 mm, depth 285 mm
- Touch screen for fast and easy operation
- 13 programmes, each with three individually configurable polymerisation stages
- The automat can also be operated as a pressure compactor
- Optional feature: Dry pressure compression up to approx. 70°C
- Rapid draining: prompt switch between the two modes
- Separate menu for each mode
- Intelligent workflow preset by the software helps the user to ensure operational safety
- Exact remaining time displayed
- Powerful, electronically controlled heating for optimal working temperature
- Pressure relief valve for protection in case of malfunction (7 bar)
- Safety lid with bayonet lock
- Dry-run protection
- Engraving in container indicating max. water level
- Time and cost saving due to thermal insulation
- Made almost entirely of stainless steel
- Low maintenance, easy to service

2 Safety Symbols used in this Manual



Warning!

This is a warning of risk situations and dangers.

Failure to observe this warning could be life-threatening. These warnings has to be observed.



Information!

This symbol draws your attention to specific features that has to be observed.

3 Safety Guidelines

Configuring and operating this equipment requires **precise knowledge** and **observance** of the instructions in this **user manual**. The equipment is designed only for its intended application.



WARNING:

Servicing and repairs should be carried out only by authorised specialists.
Disconnect the power plug before starting any maintenance work.



Make sure that the equipment is connected to the correct power source.



The safety valve on the pressure tank opens automatically if the operating pressure is more than 7 bar.



The pressure can be activated only if the door is closed completely, since a safety door contact is installed.



Dry-run protection, which switches off at 125 °C. The integrated thermal fuse works automatically. Please just wait until the unit cooled down.



Warning: Risk of scalding during the Hot Polymerisation.

Mount the thermal protection cover firmly before start-up (see p. 8)

Never open the lid while the unit is under pressure!

Always open the lid slowly!

Display information have to be followed!

Please wear heat-resistant gloves.



For safety-related reasons (hot water, pressure), only the valves and hoses meant for this purpose must be used for draining. If parts of different design are used/ installed (self-made), there is a risk of scalding!



For safety reasons, the pressure setting is limited to max. 6 bar (at 20 ° C).
Depending on the level of the heating temperature, the pressure can increase.

4 Responsibility for Operation or Damage

The responsibility for operating the unit lies exclusively with the owner or user if said unit is incorrectly serviced, maintained or altered by persons not employed by an authorised dealer or if the unit is used in a manner contrary to its specified purpose.

The unit has to be maintained and operated in accordance with this user manual.

Wassermann Dental-Maschinen GmbH is not responsible for damage arising from the **nonobservance** of these instructions.

Warranty and responsibility provisions contained in the sales and supply conditions of Wassermann Dental-Maschinen GmbH are not extended by these instructions.

5 Application

The **Polyquick 160-T95** is a pressure polymerisation unit for hot and cold polymerisation of plastics. This automat is designed for polymerisation of up to 3 flasks in flask holder or 2 cast resin flasks or rebasing frames or 6 orthodontic regulatings at one time. It can be set to a maximum temperature of 95 °C and the polymerisation pressure can be adjusted to a maximum of 6 bar. In automatic mode, the polymerisation time can be preselected up to 99 hours. A touch screen and the newly developed control panel allow the user to set the relevant parameters quickly and easily using self-explanatory symbols.

The **Polyquick 160-T95** can also be used as a pressure compactor without heating.

Furthermore, dry compression is possible up to a maximum of 70°C. For thermodynamic reasons, the display value must be increased by 10 °C;

i.e. max. 70°C dry compression = max. 80 °C display value.

Only use the unit for this type of application.

6 Before Starting

6.1 Transport

Before transporting the unit, ensure that it has been unplugged from the power socket. Make sure that it is packed correctly in order to avoid accidental damage.



Be sure to check for any transport damage when unpacking the goods. Note down any damage if found.

6.2 Installation

Open the box, remove the packing materials, and carefully lift out the unit and accessories. Check the included accessories.

The unit has to stand horizontally on a steady and even surface.



Install the unit in a place where it will not block the working area and the functionality (take the dimensions into account).



Do not install the unit outdoors or in places without proper ventilation. Before start-up, be sure the unit reaches room temperature.



It is advisable to **install the unit firmly on the drainage system**, since **very hot water** can drain off from it. This also simplifies the process of complete emptying, e.g. for cleaning.

6.3 Storage

The unit location is very important when it comes to workplace safety, even if it is only to be set up there for a short period. The room should be dry, well ventilated and vibration-free. An even temperature and wooden supports also help. The unit should not be stored or set up outdoors. If the unit is to be stored for an extended period, protect it from moisture and dust.

7 Installation/ Start-up



ATTENTION: Before start-up screw it to the swivel door!

- Thermal protection cover
- Spacer sleeve, 4 pieces
- Screw, 4 pieces

RISK OF SCALDING!



Before commissioning, please install the following connections:

Install the pressure hose included in the scope of supply and provide for an appropriate outlet.



It is advisable to **install the unit firmly on the drainage system**, since **very hot water** can drain off from it. This also simplifies the process of complete emptying, e.g. for cleaning.

After setting the workpiece, fill the unit with tap water, at most up to the engraving in the tank (**not with dry compression**). Establish a **pneumatic connection of minimum 2 bar**. If the pneumatic pipe is long, pay attention to the hose cross-section (internal diameter min. 6 mm). Every pneumatic pipe must always have a maintenance unit. Ensure a constant pressure by using the pressure reducer.

Finally, insert the plug into the socket – make sure that the voltage specification of the unit and the mains network is identical.



Never operate the unit **without water and over 80 °C (display value)**, since the heating unit immediately heats up to 60°C or to the preheating temperature (please check the preheating temperature) when the power switch is activated.

If required, the heating unit can be switched off via the display.



7.1 Setting the correct Pressure



Before filling the tank, remove the accessories.

Afterwards set the correct polymerisation pressure.

Proceed as follows (image, see 7.2):

1. Activate main switch (green rocker switch).
2. Close lid.
3. Touch the Pressure key  (image, see 7.2). **(2.5 bar default)**.
4. If the pressure is very less (min. 2 bar), increase the pressure (**max. 6 bar**) using the black regulator on the back side. Release the regulator by pulling to do the setting and press it in once again.
5. If the pressure is too high, switch off the pressure  (image, see 7.2) and release the pressure. Turn the pressure regulator on the back side in the "minus" direction several times; then, apply pressure to the tank. You can set the desired pressure by turning the regulator in the "plus" direction.



For safety reasons, the pressure setting is limited to max. 6 bar (at 20 ° C).

For an optimal pressure setting, the device should be brought up to working temperature beforehand.

7.2 Start-up

Define the unit's main parameters before switching it on. These settings are performed in the Set-Up Menu (3). Familiarise yourself with the system's various options before starting the polymerisation process. This particularly applies to functions (7) and (14). (Please see „setup menu page 1“ on page 11 of this manual).

The Start menu in Polymerisation mode

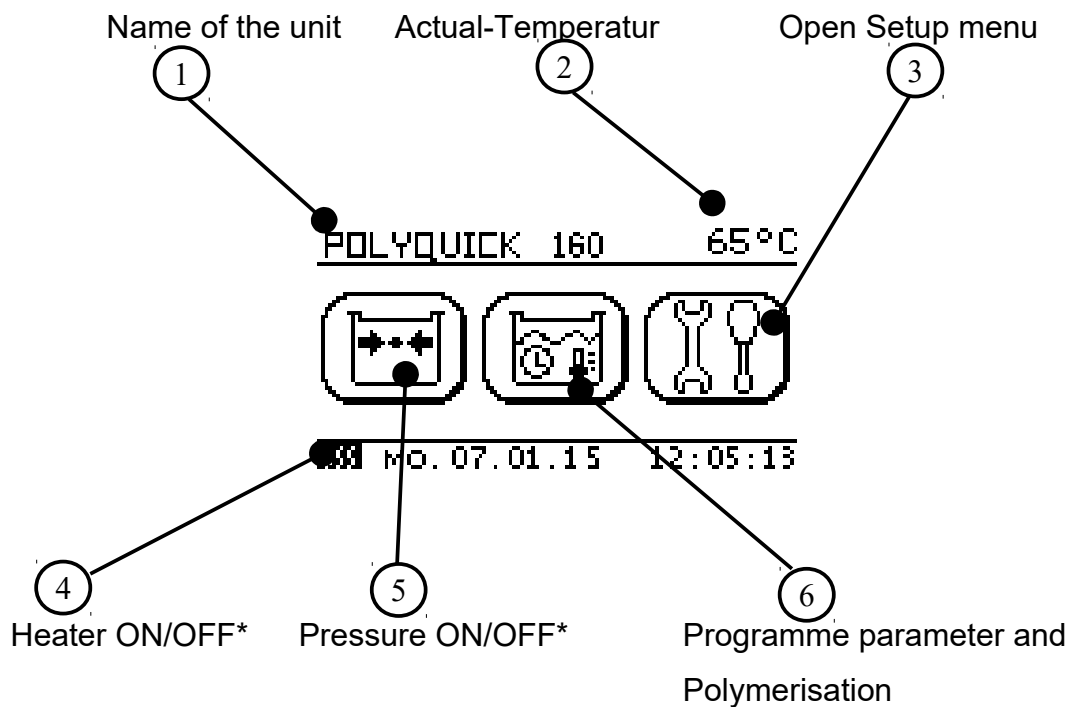

*Inverted (background is black) = ON

The Start menu in Compactor mode (without heater)

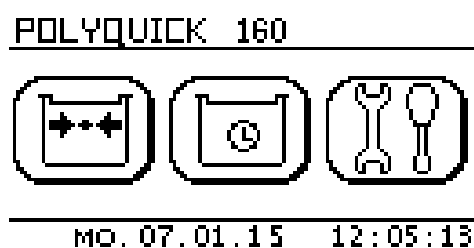

Setup menu page 1

In the Setup menu the following settings can be made:

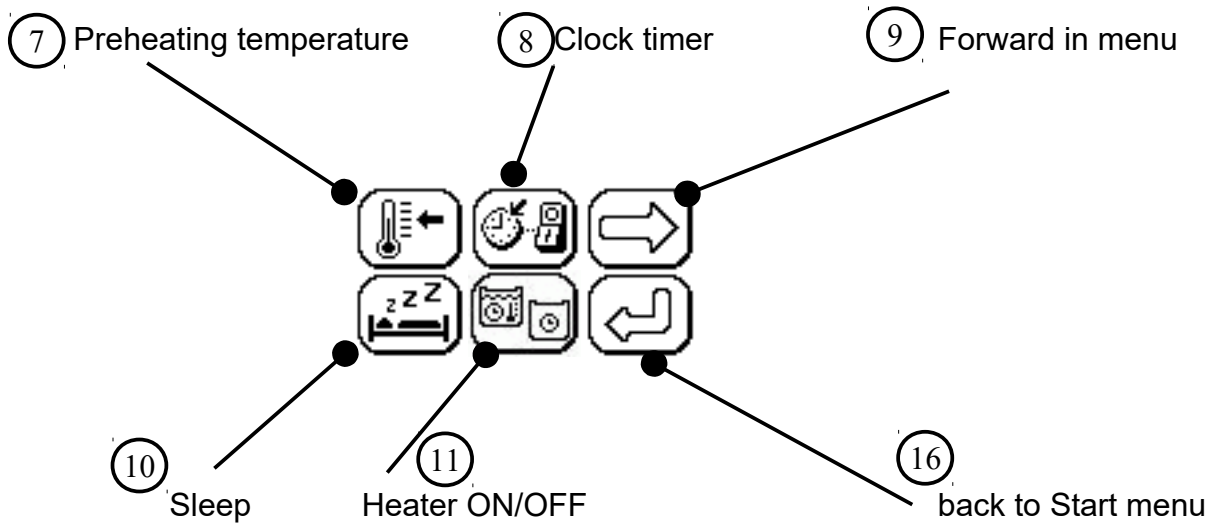

Mode: Polymerisation/ Compaction without heater

Setup menu page 2

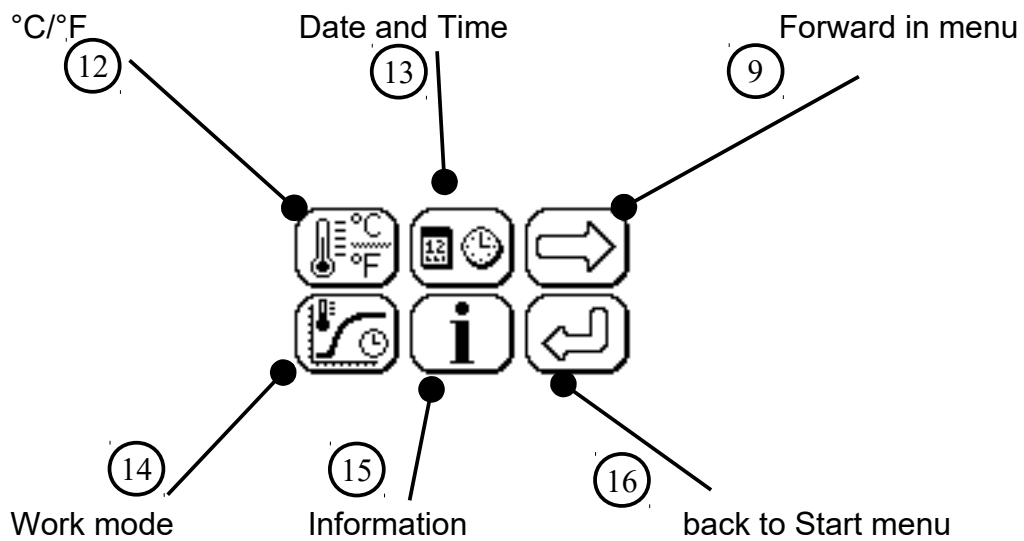

Description of features 5 – 14

Pressure ON/ OFF

Bevore starting the programme you have to choose the pressure.



Pressure regulator at 20 °C: min. 2 bar, max. 5 bar

Temperatures higher than 100 °C: Working is only possible under pressure.

If no pressure is set, the heating switches off at 100 °C.

Hence working without pressure is only possible at temperatures below 100 °C.

For further information please see 7.1 Setting the correct Pressure.

⑥ Programme parameter und Polymerisation

Defines the parameters for the programme temperature.

You can store 13 programme counter (1-13). In every counter up to three polymerisation stages #1-3 can be mapped.

Touch the numbers to change the values.

#	Temp	Time	Start
1	70°C	6:30h	▶
2	--°C	--:--h	↶
3	95°C	1:30h	↶

Polymerisation level 1 (1):



Examples of level 2 and level 3 :

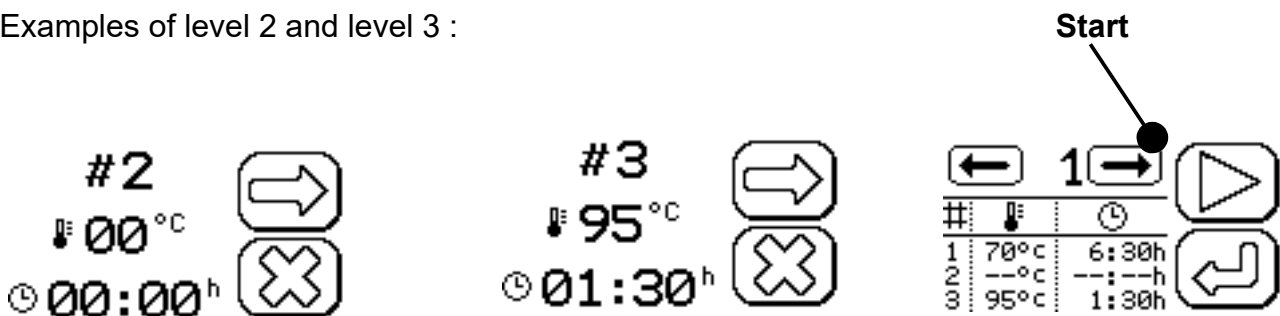

Touch the arrow (Start) to start the process of polymerisation. Pause or cancel the programme by pressing the "Stop/Pause"symbol. In programme 2-13 the practice is the same.

The Polymerisation

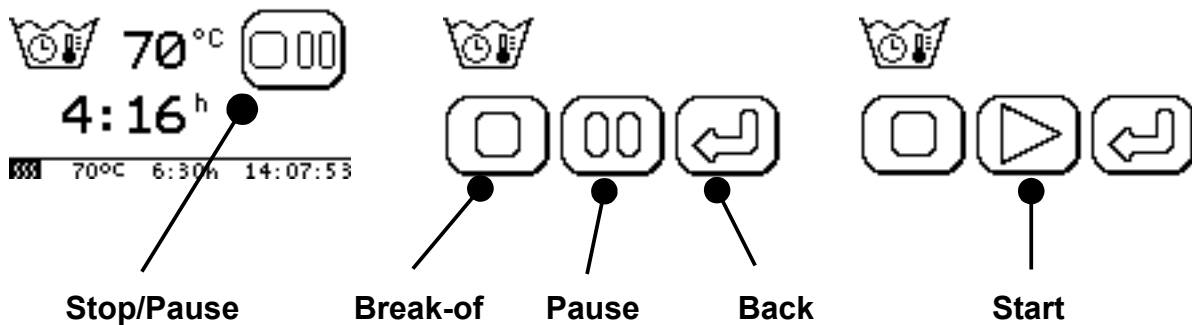

The process of dry pressure compaction is identical to polymerisation. But it operates without water and is therefore merely limited by the temperature (max. 70°C container = 80°C display).

For process-related reasons, work must be limited to a maximum of 70 °C in the container.

7 Preheating temperature

(check for dry compression up to max. 70°C container = 80°C display)

Defines the target temperature once the main switch has been activated. The pre-heat temperature also applies to waiting times and rest periods. Default: 60°C



If the programme temperature selected is higher, the temperature reverts back to this value when the programme ends.



After defining the desired working mode ¹⁴, it may make sense to adjust the pre-heat temperature of the programme temperature. This avoids long heat-up or cool-down phases.

8 **Clock timer**

This defines the weekday activation and deactivation times.

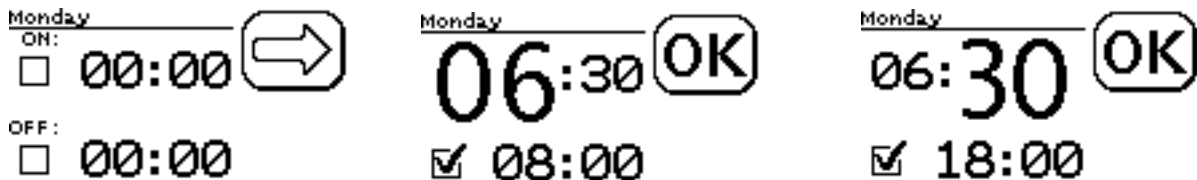

 **Programmes running currently have a higher priority; they are not switched off until complete.**

10 **Sleep button display**

POLYQUICK 160

 MO. 07.01.2015
 19:05

 AUTO-ON: Tu. 06:30

When you press the Sleep button, the unit goes into the Sleep mode (all functions except the Timer function are switched off). The unit gets actuated when you press the touch display or with the timer and heats up or cools down to the preset pre-heating temperature.

11 **Heater ON/OFF (Mode: Polymerisation/ Compaction without heater)**

Choosing the pressurepolymerisation mode (pressure and temperature) or Compactor mode (pressure without heater).

12 Selection of the temperature unit (Fahrenheit or Celsius)

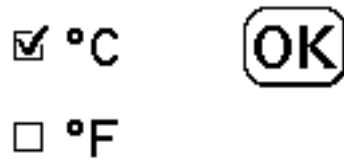

13 Pictograms for the time and date function cycle.

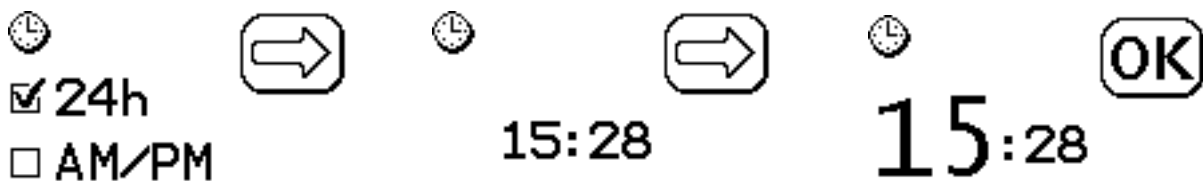

14 Selection of the working mode

Defines whether the polymerisation process should start immediately or only after the heating value has been reached.

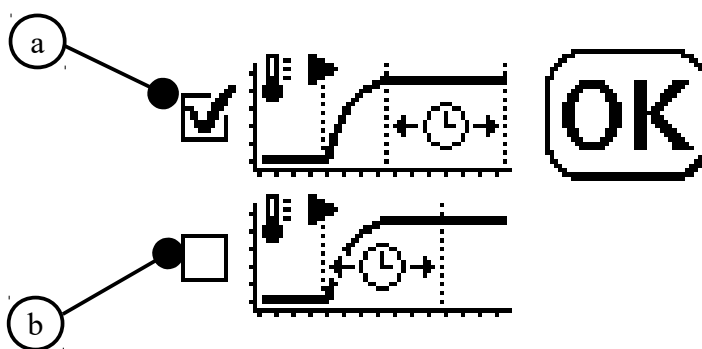

(a) (Default) The unit heats to the temperature programmed under **6** after reaching this value, the result measured is validated by a control cycle. If the value is confirmed, the wax polymerisation process will start.

(b) The programmed polymerization begins immediately.

15 Information

Here the parameters of the touch screen, sensors, hardware and software are displayed.

8 Operation

8.1 General Operating Instructions

All instructions for using the unit, whether in verbal or written form, are based on our own experience and experimentation and can only be regarded as guidelines.



Please put on heat-resistant gloves



During longer periods of non-use please disconnect the power plug.



Dry compression up to max. 70°C container = 80°C display

For **dry pressure compaction**, operate the unit with pressure but without water.

It takes about 30 to 45 minutes to heat up to the desired temperature; without pressure, it takes a very long time to reach the set temperature.

8.2 Operation

- Open the lid.
- First set the workpieces, for polymerisation then fill the water till all the polymerisation parts are covered (max. up to the engraving = Marking in the tank) and close the lid up to the stop.
- Switch on the main switch, the unit will automatically heat up to 60°C or up to the value selected as the pre-heating temperature (A) (check the pre-heating temperature) . When warning appears, close the lid.
- Activate the pressure. (5)
- The process of polymerisation/ dry pressure compression starts when you touch the symbol (6). After the process has ended, the temperature falls to the preset temperature again.

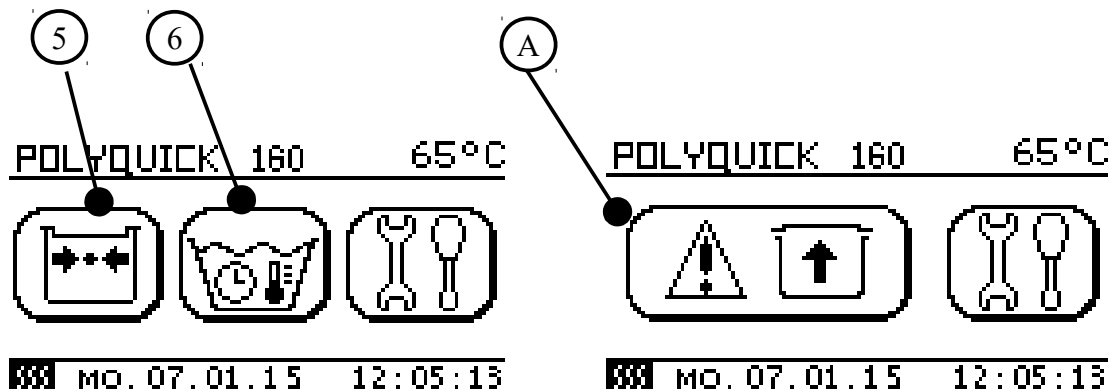

For process-related reasons, the set display value for dry pressure compaction may not exceed 80 °C. This corresponds to an internal container temperature of max. 70°C +/- 4 °C.

At higher temperatures, the built-in temperature protection (boil-dry protection) could interrupt the program sequence!

9 Troubleshooting

Fault	Cause	Solution
Polyquick 160-T95 does not heat	Lid is open (p. 20,fig. 1)	Close lid against safety contact.
	Temperatur-programme-parameter is to low	Adapt the parameters.
	Preheating temperature is to low	Adapt the parameters.
	Heater faulty	Please contact our service department.
Pressure does not increase in chamber	Lid seal O-ring faulty	Check O-ring and replace if necessary.
	Pressure regulator set to 0 (pressure gauge).	Check pressure and adjust if necessary.
	Lid not fully closed	Close lid against safety contact or contact faulty.
	Thermal fuse off or Thermal fuse faulty	Let the unit cool down and try again Replace faulty fuse. Please contact our service department.
Display blank	Thermal fuse off	Let the unit cool down and try again
	or Thermal fuse faulty	Replace faulty fuse. Please contact our service department.
Touchscreen malfunction	Calibrate the touch display	Switch on the unit. <u>While</u> the logo of Wassermann appears please contact the touch display two times. Then you will reach the self-explanatory touch panel-calibration* (p. 20, fig. 2-3).
	Touchscreen under pressure	Please contact our service department.
	Screen protector damaged?	Please contact our service department.
Unit does nothing	Blown fuse	Check the two fuses seperately. Disconnect the power plug before replacing blown fuse at the rear of unit. Item no. 582013 Fuse 6,3 AM/250 V D 5 x 20



If the previous recommendations do not solve the problem, contact your dental depot or our service department.

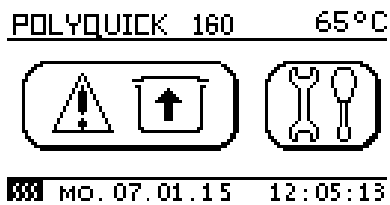

Fig. 1

*** VIDEO: CALIBRATION**

<https://t1p.de/TDRec>



Fig. 2

Touch Panel
Calibration
(Press Cross)

Fig. 3



10 Care and Maintenance

10.1 Cleaning



Disconnect the power plug before starting any maintenance work.

The identification plate has always to be kept in easily legible condition and has not to be removed.



Remove external dirt from time to time with some form of cold cleaner.

Use only cold cleaners to avoid damaging the paintwork or removing the lettering.

10.2 Maintenance

At regular intervals, check the cover gasket (item no. 380032) for damages; for this purpose, remove the gasket ring (reddish brown silicon ring) from the ring groove of the pressure tank using a pair of blunt tweezers. The ring groove for holding the gasket ring must always be kept clean.

Use Vaseline or oil while inserting the gasket ring back into the ring groove. If the lid often is stiff the O-ring also can be used with special lubricant Super O-Lube or similar.

Check the functioning of the lid safety switch by opening and closing the lid multiple times; a soft click must be audible while closing or opening.



Change the sealing ring every 18 months.

10.3 Repairs



Servicing or repairs to the unit has only to be carried out by qualified technicians.

Only original spare parts are to be used. Responsibility for the product is voided if unauthorised persons alter it or if inappropriate components are installed.

10.4 Spare Parts

If necessary please contact our service hotline phone.

10.5 Service Hotline 0049 (0)40 / 730 926 -20/ -24

10.6 Scope of Delivery/ Accessories

Polyquick 160-T95 (Item no. 170976)

Incl. in delivery:

- Flask bracket support
- Flask basket
- Compressed air hose, 2 m
- Discharge hose, 2 m
- Hose clip Ø 12-20 x 9
- *Thermal protection cover**
- *Spacer sleeve, 4 pieces**
- *Screw, 4 pieces**



**Before start-up*
screw it to the swivel door!
RISK OF SCALDING!



Accessories/ Spare parts	Item no.
Flask bracket support	170508
Flask basket	170499
Compressed air hose, per meter	320026
Discharge hose, per meter	320031
Fuse 6,3 AM/250 V D 5 x 20	582013

10.7 Warranty



The warranty period for our equipment is 12 months. If faults occur within the warranty period, contact your dental depot or get in touch directly with our service department.

Your equipment should only be operated in perfect condition. If faults occur which could harm operators or third parties, the unit should not be used until it has been fixed.

This warranty does not cover damage caused by improper use, external mechanical causes, transport damage or interference with the unit by unauthorized persons.

11 Technical Data

Polyquick 160-T95	Item no.: 170976
Voltage*	220–240 V / 50/60 Hz
Power consumption	4.2 A
Output	1000 W
W x H x D	325 x 435 x 375 mm
Weight	22 kg
Compressed air connection	min. 2 bar
Operating pressure	max. 6 bar
Pressure chamber	Ø 150 mm, depth 285 mm

The noise level of the unit amounts to ≤ 70 dB (A).

*Other voltages on request.



Technical changes reserved.

12 Disposing of the Unit

The unit has to be disposed by an authorized recycling operation. The selected company has to be informed of all possibly health-hazardous residues in the unit.

12.1 Information on Disposal for Countries within the EU



To conserve and protect the environment, prevent environmental pollution and improve the recycling of raw materials, the European Commission adopted a directive that requires the manufacturer to accept the return of electrical and electronic units for proper disposal or recycling.

Within the European Union units with this symbol should not therefore be disposed of in unsorted domestic waste.

For more information regarding proper disposal please apply at your local authorities.



Your Contact at Wassermann Dental-Maschinen

You have questions concerning our products or services? Contact us! We guarantee quickest possible handling and we will provide you personally with competent, dedicated help. Thank you for contacting us!

Phone: +49 (0)40/ 730 926 - 24

export@wassermann-dental.com

13 EU Declaration of Conformity

in accordance with 2014/35/EU (Low Voltage Directive) and 2014/30/EU (Electromagnetic Compatibility Directive) and 2006/42/EC (Machinery Directive) and 2011/65/EU (RoHS Directive) and 2014/68/EU (Pressure Units Directive)

Manufacturer:	W A S S E R M A N N Dental-Maschinen GmbH Rudorffweg 15-17 21031 Hamburg Germany	Product description:	Polimerisation Unit and Compactor for dental applications
Model:	Polyquick 160-T95	Item no.	170976
Applicable standards:	DIN EN 61010-1 DIN EN 61000-6-3 DIN EN 61000-6-1 DIN 45635-1 DIN EN 60335-1		

Hiermit wird bestätigt, dass die oben bezeichnete Maschine den genannten EU-Richtlinien entspricht. Diese Erklärung wird ungültig, falls die Maschine ohne unsere Zustimmung verändert wird.

This is to confirm that the above mentioned machine complies with the described EU guidelines. This declaration becomes invalid if the machine is modified without our approval.

Cette machine est conforme aux normes en vigueur d'Union européenne. Cet avis est nul et non avenant si cette machine est modifiée sans notre accord.

Esta máquina, anteriormente mencionada, cumple con los límites requeridos por el reglamento UE. Ahora bien, esta declaración quedará invalidada en caso de realizar modificaciones al aparato sin nuestra aprobación.

Hiermee wordt bevestigd dat bovengenoemde machine voldoet aan de voorgeschreven EU normen. Deze verklaring verliest geldigheid als er zonder onze uitdrukkelijke toestemming wijzigen aan de machine worden aangebracht.

Place, date: Hamburg, 2022-05-10

Company stamp :



Signature: _____
Sven Wassermann
(Managing Director)



WASSERMANN
DENTAL-MASCHINEN GMBH
Rudorffweg 15-17 · 21031 Hamburg

Notes:



Wassermann Dental-Maschinen GmbH
Rudorffweg 15–17 · 21031 Hamburg · Germany
Phone: +49 (0)40 730 926-20/ -24 · Fax: +49 (0)40 730 37 24
export@wassermann-dental.com · www.wassermann.hamburg



/WassermannDentalmaschinen