

Boil Out and Polymerisation Unit **Wapo-Ex 8 plus**



MANUAL

Dear customer,

Thank you for choosing a product from the Wassermann range. Wassermann Dental-Maschinen incorporates the highest standards of quality and the latest technology. In order to enjoy maximum performance and years of trouble-free operation, please read this user manual carefully before you connect this device and start work, and operate the device according to the recommended guidelines. The operation safety and the functionality of this device can only be guaranteed if you follow both the general safety guidelines and the applying laws to prevent accidents as well as the precautions given in this user manual. We are not liable for any damages which occur due to inappropriate usage or faulty operation of this device.



Make sure that anyone using this device has read and understood this user manual.

Keep this user manual in a safe place where it can be referred to as required at any time.



The unit complies with the relevant EU guidelines.



The unit is subject to the EU guidelines 2012/19/EU (WEEE Directive).

Company address:

Wassermann Dental-Maschinen GmbH

Rudorffweg 15-17

21031 Hamburg, Germany

Phone : +49 (0)40 730 926 -20/ -24 Fax.: +49 (0)40 730 37 24

export@wassermann-dental.com

www.wassermann.hamburg

www.facebook.com/WassermannDentalmaschinen

Contents

1 Features.....	4
2 Application.....	4
3 Safety Symbols used in this Manual.....	5
4 Safety Guidelines.....	5
5 Responsibility for Operation or Damage.....	6
5.1 Warranty.....	6
6 Before Starting.....	6
6.1 Transport.....	6
6.2 Installation.....	7
6.3 Storage.....	7
7 Installation/ Start-up/ Menu Functions.....	8
8 Operation.....	18
8.1 General Operating Instructions.....	18
8.2 Boiling Out Operation.....	20
8.3 Hand Shower.....	20
8.4 Polymerisation Operation.....	21
9 Troubleshooting.....	22
10 Maintenance.....	23
10.1 Cleaning.....	23
10.2 Servicing.....	24
10.3 Repairs.....	24
10.4 Spare Parts.....	24
10.5 Service Hotline 0049 (0)40 730 926 -20/ -24.....	24
10.6 Scope of Delivery/ Accessories.....	24
11 Technical Data.....	25
12 Disposing of the Unit.....	26
12.1 Information on Disposal for Countries within the EU.....	26
13 EU Declaration of Conformity.....	27

1 Features

- Compact tabletop automat for boil out or polymerisation up to 8 flask halves
- Fully automatically
- Reliable polymerisation results
- Convenient boil out process, easy access to flask baskets
- Spray system in the middle, easy to mount/ dismount
- Quick exchange of both functions boil-out and polymerisation
- Touch screen for fast and easy operation
- Integrated timer
- Optical and acoustic lack of water warning
- Low water cut-out in order to protect the heating
- Thermostat protected, gasketless submersible pump, silent and maintenance-free
- For manual scalding: Integrated hand spray made of non-conductive plastic, lowered lid and all-round splash protection made of stainless steel
- Easy to clean without tools
- Designed for long durability
- High quality construction, most parts made of stainless steel
- Energy saving thermal insulation

2 Application

The **Wapo-Ex 8 plus** is suitable for automatic boiling out or for the water bath polymerisation of up to 8 flask halves, as well as for manual scalding of small parts in the lowered lid with the hand spray. It can be used to fully automatically polymerise all commercially available plastics through long-term polymerisation (up to 99 hours) as well as through boiling polymerisation (up to 99 °C).

Only use the device for this type of application.

3 Safety Symbols used in this Manual



Warning!

This is a warning of risk situations and dangers.
Failure to observe this warning could be life-threatening.
These warnings has to be observed.



Information!

This symbol draws your attention to specific features that has to be observed.

4 Safety Guidelines

Configuring and operating this equipment requires ***precise knowledge*** and ***observance*** of the instructions in this ***user manual***. The equipment is designed only for its intended application.



WARNING:

Servicing and repairs should be carried out only by authorised specialists.
Disconnect the power plug before starting any maintenance work.



Make sure that the equipment is connected to the correct power source.



Attention! Danger of Scalding!

Do not touch the hand shower at the nozzle or hose.
Do not point the spraying jet towards humans or animals.
The water, which comes out of the nozzle can reach temperatures of 95°C;
therefore only use the hand shower in the area of the screen cover or the hand basin.

5 Responsibility for Operation or Damage

The responsibility for operating the device lies exclusively with the owner or user if said device is incorrectly serviced, maintained or altered by persons not employed by an authorised dealer or if the device is used in a manner contrary to its specified purpose. The unit has to be maintained and operated in accordance with this user manual. Wassermann Dental-Maschinen GmbH is not responsible for damage arising from the **nonobservance** of these instructions.

Warranty and responsibility provisions contained in the sales and supply conditions of Wassermann Dental-Maschinen GmbH are not extended by these instructions.

5.1 Warranty

 The warranty period for our equipment is 12 months. If faults occur within the warranty period, contact your dental depot or get in touch directly with our service department.

Your equipment should only be operated in perfect condition. If faults occur which could harm operators or third parties, the unit should not be used until it has been fixed.

This warranty does not cover damage caused by improper use, external mechanical causes, transport damage or interference with the unit by unauthorized persons.

6 Before Starting

6.1 Transport

Before transporting the unit, ensure that it has been unplugged from the power socket. Make sure that it is packed correctly in order to avoid accidental damage.

 Be sure to check for any transport damage when unpacking the goods. Note down any damage if found.

6.2 Installation

Open the box, remove the packing materials, and carefully lift out the device and accessories. Check the included accessories.

The device has to stand horizontally on a steady and even surface.



Install the device in a place where it will not block the working area and the functionality (take the dimensions into account).



Do not install the unit outdoors or in places without proper ventilation. Before start-up, be sure the device reaches room temperature.



We strongly recommend to **install the unit firmly to the discharge system**, since it is equipped with an automatic water overflow discharge system, i.e. too much filled very hot water runs out automatically, even when the discharge cock is closed. Furthermore complete emptying for cleaning purposes etc. is thus simplified.



Avoid overfilling and check the overflow system / drainage system. Strong overfilling **can damage the electronics** in the medium term.

For damage caused by improper handling, no liability is assumed.

6.3 Storage

The unit location is very important when it comes to workplace safety, even if it is only to be set up there for a short period. The room should be dry, well ventilated and vibration-free. An even temperature and wooden supports also help. The unit should not be stored or set up outdoors. If the unit is to be stored for an extended period, protect it from moisture and dust.

7 Installation/ Start-up/ Menu Functions



The container lid is equipped with a safety switch.

If you open the lid, the program is interrupted.

Only applies to the automatic program - not to manual operation.



Before starting the unit, connect up the following:

Firmly clamp the supplied drainage hose to the device and ensure there is a suitable drainage facility.

- Insert the plug into the socket – make sure that the voltage information between the device and the mains network is identical.
- The filter mat is already placed with the white side facing down.
- Fill the unit with water and **Wachs-Ex** up to the overflow limit (21 litres max.)
Dosage: approx. 45 ml / 21 litres water.
- Switch on the mainswitch (green rocker switch).
- Symbol **(A)** (water deficit) must not appear.
- Also avoid an overflow!

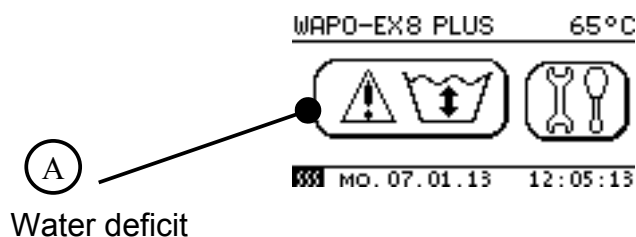

Make sure you define the device's main parameters before switching it on. These settings are performed in the **set-up menu** (3). Familiarise yourself with the many options which the system offers before starting to boil out. This applies in particular to functions (7) **start temperature** and (14) choice of **work mode**.

The Set-Up Menu

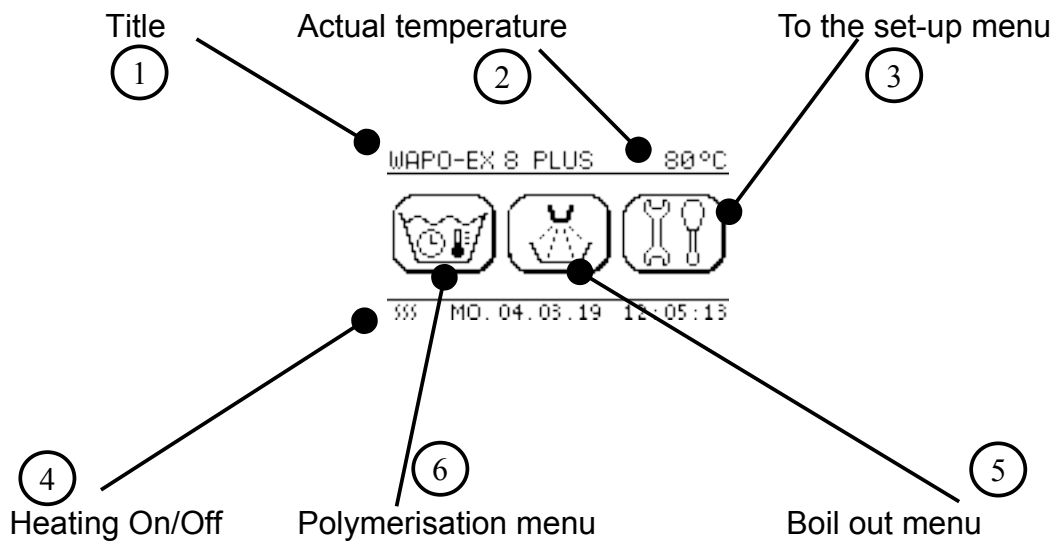

The Set-Up Menu Page 1

Make the following settings in the set-up menu:

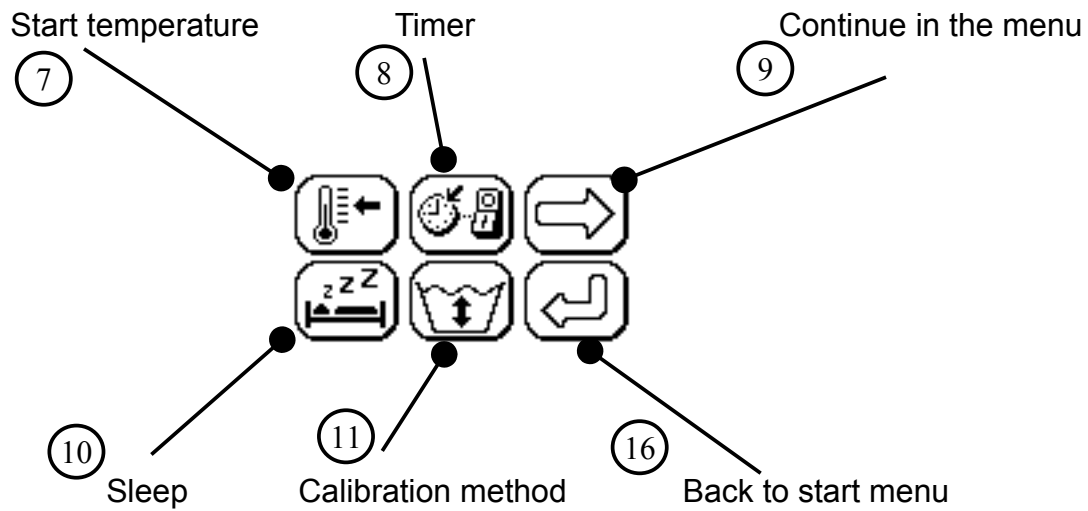

The Set-Up Menu Page 2

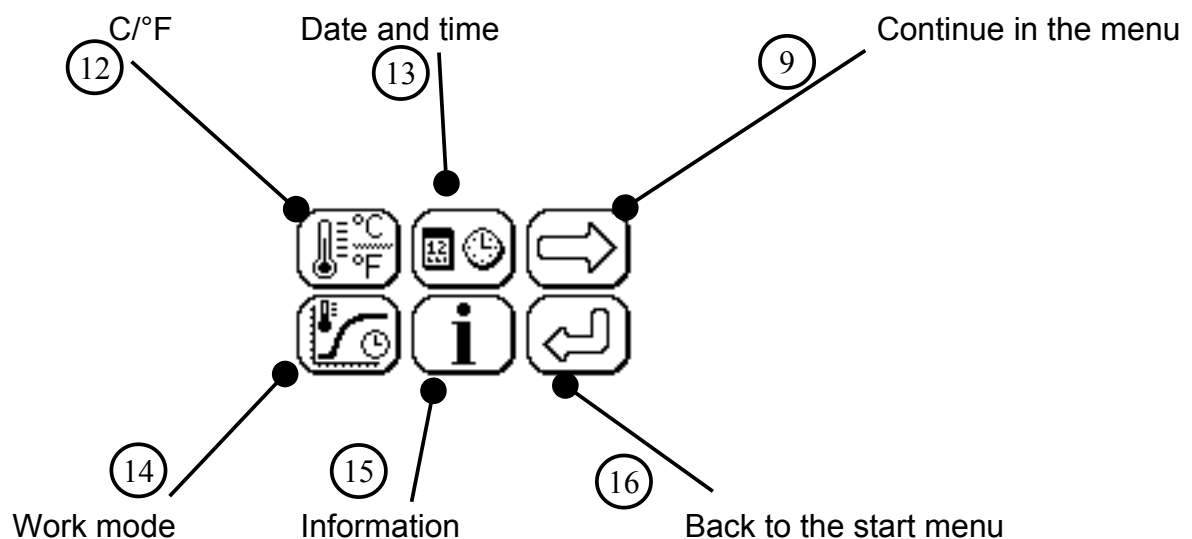

Description of Functions 5 - 14



The manual boil out process is initiated by touching the **boil out symbol**.

i If the temperature falls below 63 °C the process is aborted and the **heating symbol** (c) appears. In order to continue working the process must be manually started by touching the **boil out symbol** once again.

i To relieve the hose and hand shower of pressure when not in use, the ball cock should always be returned to the horizontal basic position.

5b **Automatic Boil Out Menu (Ball cock basic position: „lever horizontal“)**

Here you can set the temperature and the time for the boil out process. By tapping the numbers increases and the values can then be changed.



Press the Start button to start the program. Interrupt or stop the program by using the Stop/ Interrupt button.

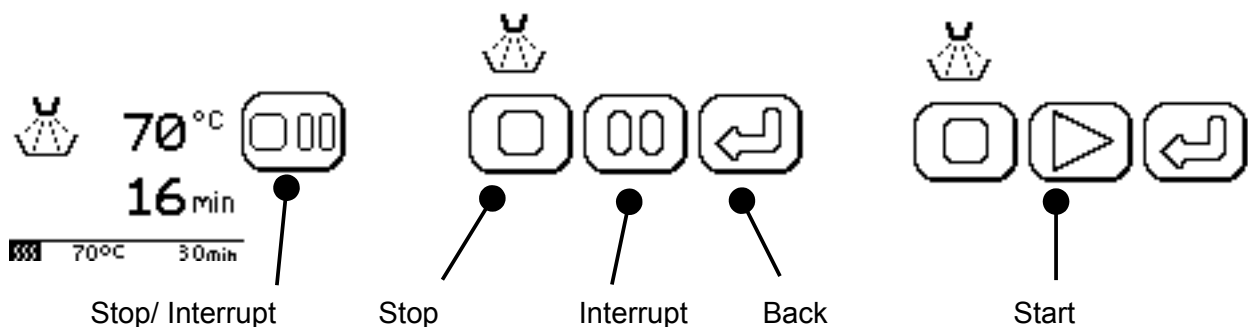

6a Program Parameters

Defines the parameters for the program temperature and time. Touch the numbers to change the values. It is possible to store up to three polymerization steps # 1-3.

#	🌡️	🕒	▶️
1	70°C	6:30h	⏪
2	--°C	--:--h	
3	95°C	1:30h	

Polymerization Step 1:



Examples of the Steps 2 and 3:



Touch the arrow to start the polymerization.
Interrupt or cancel the program using Start/Stop.

6b

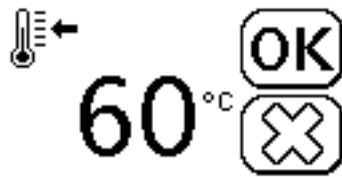

Polymerization

14

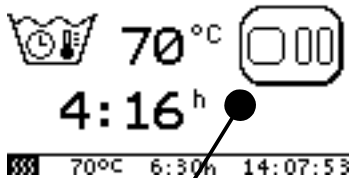

Stop / Pause



Cancel



Pause



Back



Start

7 **Preheating Temperature**

Defines the target temperature once the main switch has been activated.

The preheat temperature also applies to waiting times and rest periods. Default: 65°C



If the programme temperature selected is higher, the temperature falls back to this value when the programme ends.



After defining the desired mode it may make sense (14) to adjust the preheat temperature of the programme temperature. This avoids long heating up or cooling down phases.

The preheating temperature can be up to 8 °C higher than the program temperature so that the program can run. The controller will then adjust (reduce) the temperature to the programmed value.

8 Timer

This defines the weekday activation and deactivation times.

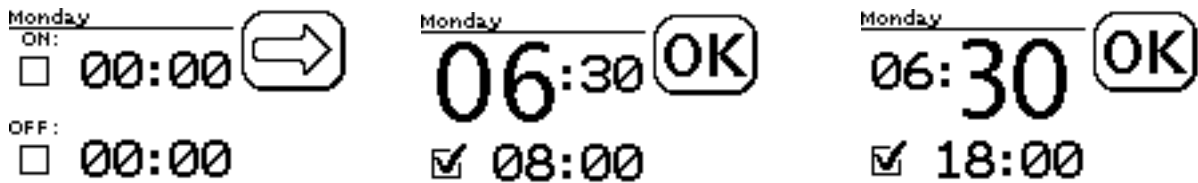

Programs running currently have a higher priority; they are not switched off until complete.

10 Sleep Button Display

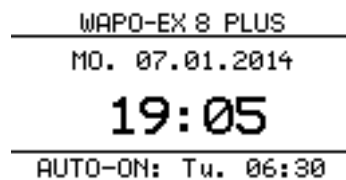

Press the Sleep button to switch the system to sleep mode.

11 Definition of Calibration Method



DEF: Default (calibrated for mains water)

CAL Calibration (only necessary for extreme deviations in water quality)

 This measure defines the conductance of the water!

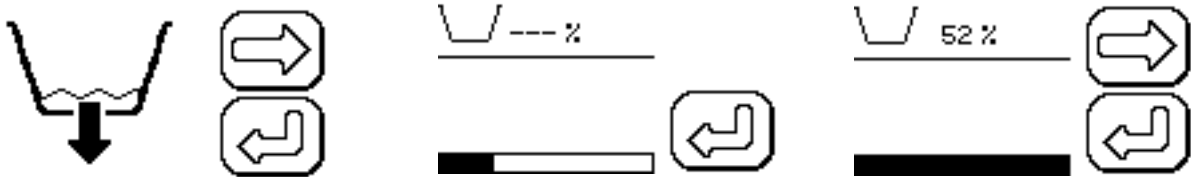

Drain water

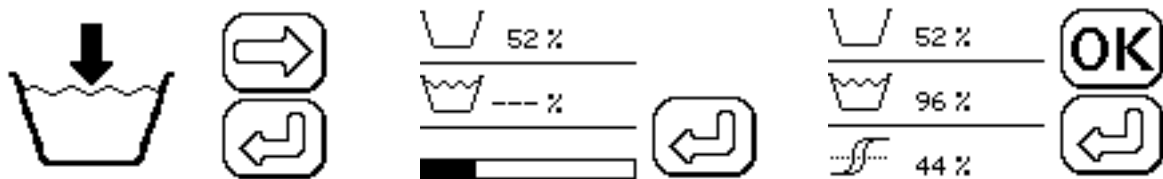

Replenish water

⑫ Choose between °C Celsius and °F Fahrenheit

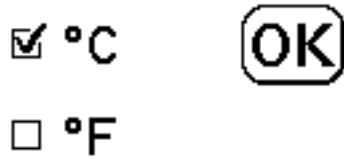

⑫a Calibrate the temperature with a relative offset

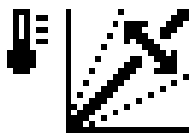

+0.0 %

Change the value and the algebraic sign by tapping on the respective numeral.

The relative offset of the heating curve causes a correction of the temperature value in percent to the measured value. As shown in the symbol, the angle of the heating curve is adjusted when you change this value. The relative offset value can be set in the range of -9.9% to +9.9%.

⑫b Calibrate the temperature with an absolute offset



+0.0 °C

Change the value and the algebraic sign by tapping on the respective numeral.

To correct the heater curve by a value in °C or °F, you can use the absolute offset of the heater curve. As shown in the symbol, the zero crossing of the heating characteristic shifts when this value is changed. The absolute offset value can be set in the range of -9.9°C to +9.9°C.

⑬ Pictogram for the Sequence in Time and Date Function

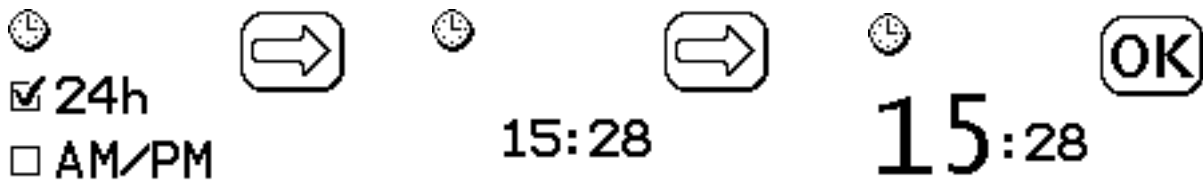

⑭ Choice of Working Mode

Defines whether the time should start immediately or once the heating value has been reached.

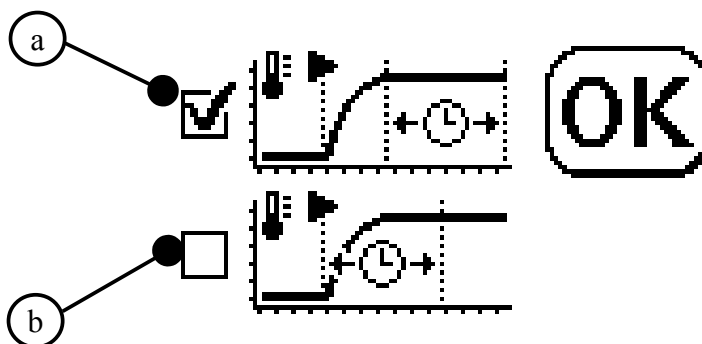

(a) (Default) Unit heats up to the temperature programmed via ⑤ taking into account any heat losses caused by the conveying pump. After reaching this value, the result measured is validated by a control cycle. If the value is confirmed, the polymerization will start.

(b) The programmed polymerization starts immediately, but the earliest at **65 °C** Celsius. Please select a suitable preheating temperature ⑦ (see page 13.)

8 Operation

8.1 General Operating Instructions

All instructions for using the unit, whether in verbal or written form, are based on our own experience and experimentation and can only be regarded as guidelines.



The **Wapo-Ex 8 plus** is not ready to use until the temperature exceeds 65 °C, i.e. the pump will not start operating until the desired temperature is reached.



The **Wapo-Ex 8 plus** is protected against dry running in order to prevent the heating from burning out (flashing symbol). While the program is running, an alarm sounds when there is insufficient water. Take care that the water level is always above the white plastic ring (see in the housing), as the heating and the program will otherwise shut down automatically!

An additional safeguard protects the heating against overheating; it is automatically deactivated at above 97°C.



Avoid overfilling and check the overflow system / drainage system. Strong overfilling can damage the electronics in the medium term. For damage caused by improper handling, no liability is assumed.



Wear heat-retardant gloves when working with the **Wapo-Ex 8 plus**.



Attention! Danger of Scalding!

Do not touch the hand shower at the nozzle or hose.

Do not point the spraying jet towards humans or animals.

The water, which comes out of the nozzle can reach temperatures of 95°C; therefore only use the hand shower in the area of the screen cover or the hand basin.



During boiling out with the hand shower you must shift the ball cock (situated at the right side at the top of the housing) to the vertical position.

To relieve the hose and hand shower of pressure when not in use, the ball cock should always be returned to the horizontal basic position.



Unplug the device if it is not in use for a longer period.

8.2 Boiling Out Operation

- Fill the unit with water and **Wachs-Ex** up to the overflow limit (21 litres max.)
Dosage: approx. 45 ml / 21 litres water.
- Also avoid an overflow!
- Activate main switch (green rocker switch).
- Check the water level – the low water alarm (A) must not flash.
- Place prepared cuvettes in the device clamp.
- Automatic boil out (temperature/time) is started by the (6) symbol. After the boil out process has ended, the temperature falls/rises to the preset temperature (7) again (see page 13).
- For the manual boil out process the ball cock must be returned to the vertical position. Then the manual boil out process is initiated by touching the boil out symbol (5).
- To stop the process touch the boil out symbol (5) once again.

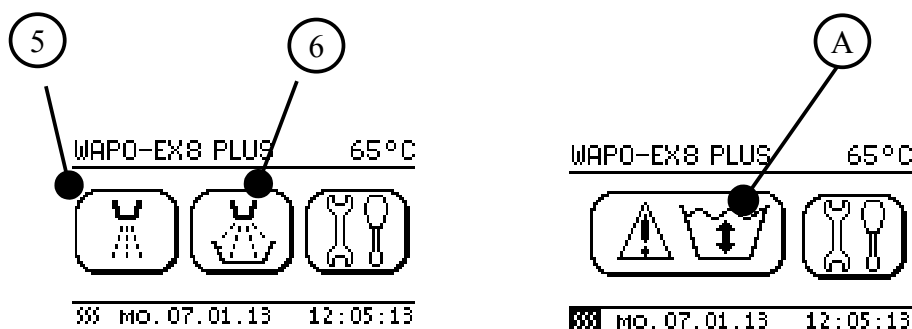

8.3 Hand Shower

In its ready state (> 65 °C) you can activate the hand shower at any time by moving the ball cock to the vertical position. The settings are as described in section 7 **Installation/ Commissioning/ Menu Functions**.

Always return the ball cock to its basic position after use, i.e. in a horizontal position facing back.



Please take note of the warning indications.

8.4 Polymerisation Operation

- Fill the work device with mains water to above the white plastic ring in the container (max. 21 litres).
- Activate main switch (green rocker switch).
- Check the water level – the low water alarm (A) must not flash.
- Place prepared cuvettes in the device clamp.
- The polymerization is started by touching the symbol (6b) or alternatively via the parameter menu (6a)
- After the polymerizations process has ended, the temperature falls/rises to the preset temperature again. (7) (see page 13).

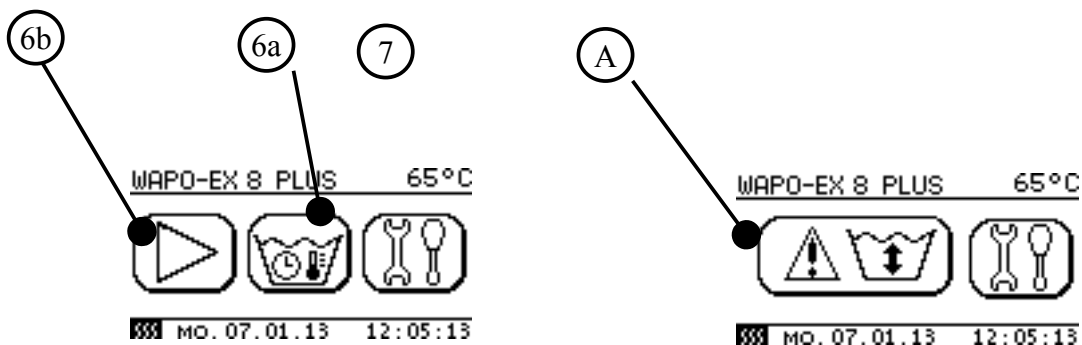

Water level sensor

9 Troubleshooting

Fault	Cause	Solution
Wapo-Ex 8 plus does not heat up	Dirty level sensor	Clean level sensor
	Water level too low	Add water
Water-level LED comes on and warning tone sounds. <i>Fig. 1.</i>	Dirty level sensor	Clean level sensor
	Water level too low	Top up water until control light goes off
	Re-calibrating the touch display	Turn the unit on and while the Wassermann logo appears tap the touch display twice. This will take you to the self-explanatory touch panel calibration process. <i>Fig.: 2-3</i>
Programme not starting although set temperature has been reached.	In mode (a) the unit intentionally overheats by 1°C and waits briefly to validate the value.	This is not a fault, please wait roughly 45 sec.



If the above recommendations do not solve the problem, contact your dental depot or our service department.

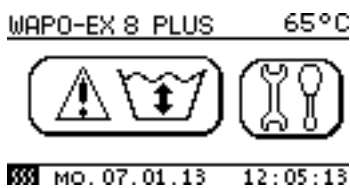

Fig. 1



Fig. 2

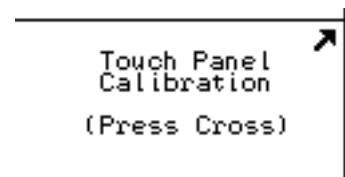

Fig. 3

10 Maintenance

10.1 Cleaning



Disconnect the power plug before starting any maintenance work.

The identification plate has always to be kept in easily legible condition and has not to be removed.



Remove external dirt from time to time with some form of cold cleaner.

Use only cold cleaners to avoid damaging the paintwork or removing the lettering.

The equipment should be cleaned at regular intervals to ensure trouble-free operation.

Once a week

- Change water and add **Wachs-Ex**.
- **Dosage: approx. 45 ml / 21 litres water**
- Clean the level tracer (white plastic ring), i.e. with a nail-brush.

Every 2 weeks

- Replace the filter mat (white side facing down).

Every 4 weeks

- Clean the unit with **Kalk-Ex**.
- **Dosage: approx. 300ccm Kalk-Ex per full tank (21 litres water)**.
- If there is considerable limescale present, increase the amount of Kalk-Ex appropriately.
- The *initial supply* of Kalk-Ex comes with the machine.



Warning:

Leave Kalk-Ex to work for a maximum 12 hours.

Then drain the tank and rinse thoroughly.



Warning!

Please clean the water level sensor at least every 14 days with a brush.



10.2 Servicing

The unit does not require any servicing. Just make sure that the device is kept clean.

10.3 Repairs



Servicing or repairs to the unit has only to be carried out by qualified technicians. Only original spare parts are to be used. Responsibility for the product is voided if unauthorised persons alter it or if inappropriate components are installed.

10.4 Spare Parts

If necessary please contact our service hotline phone.

10.5 Service Hotline 0049 (0)40 730 926 -20/ -24

10.6 Scope of Delivery/ Accessories

Included in delivery:

- Service set (4 filter mats, 1 L lime remover, 2 L wax remover)
- Discharge hose, 1.5 m
- Hose clip Ø 20-32 x 12.2

Accessories:	Item no.:
Mobile stand (W 620 x H 550 x D 430 mm)	170120
Service set (4 filters, 1 l lime remover, 2 l wax remover)	170021
Discharge hose, PVC hose 19 x 4 (3/4"), per meter	320030

11 Technical Data

Wapo-Ex 8 plus	Item no.: 170977
Voltage*	220–240 V / 50/60 Hz
Power consumption	9 A
Output	2000 W
W x H x D max. W x H x D (housing)	660 x 585 x 480 mm 615 x 550 x 425 mm
Weight	41 kg
Noise emission	≤ 70 dB (A)
Capacity	21 l

*Other voltages on request.

The noise level of the unit amounts to ≤ 70 dB (A).



Technical changes reserved.

12 Disposing of the Unit

The unit has to be disposed by an authorized recycling operation. The selected company has to be informed of all possibly health-hazardous residues in the unit.

12.1 Information on Disposal for Countries within the EU



To conserve and protect the environment, prevent environmental pollution and improve the recycling of raw materials, the European Commission adopted a directive that requires the manufacturer to accept the return of electrical and electronic units for proper disposal or recycling.

Within the European Union units with this symbol should not therefore be disposed of in unsorted domestic waste.

For more information regarding proper disposal please apply at your local authority.

13 EU Declaration of Conformity

in accordance with 2014/35/EU (Low Voltage Directive) and 2014/30/EU (Electromagnetic Compatibility Directive) and 2006/42/EC (Machinery Directive) and 2011/65/EU (RoHS Directive)

Manufacturer: **W A S S E R M A N N** Product description: Boil Out Unit for dental application
Dental-Maschinen GmbH
Rudorffweg 15-17
21031 Hamburg
Germany

Machine type: Wapo-Ex 8 plus Item no. 170977

Applicable standards
DIN EN 61010-1
DIN EN 61000-6-3
DIN EN 61000-6-1
DIN 45635-1
DIN EN 60335-1

Hiermit wird bestätigt, dass die oben bezeichnete Maschine den genannten EU-Richtlinien entspricht. Diese Erklärung wird ungültig, falls die Maschine ohne unsere Zustimmung verändert wird.

This is to confirm that the above mentioned machine complies with the described EU guidelines. This declaration becomes invalid if the machine is modified without our approval.

Cette machine est conforme aux normes en vigueur d'Union européenne. Cet avis est nul et non avenant si cette machine est modifiée sans notre accord.

Esta máquina, anteriormente mencionada, cumple con los límites requeridos por el reglamento UE. Ahora bien, esta declaración quedará invalidada en caso de realizar modificaciones al aparato sin nuestra aprobación.

Hiermee wordt bevestigd dat bovengenoemde machine voldoet aan de voorgeschreven EU normen. Deze verklaring verliest geldigheid als er zonder onze uitdrukkelijke toestemming wijzigingen aan de machine worden aangebracht.

Place, date: Hamburg, 2020-10-02

Company stamp :



Signature: _____
Sven Wassermann
(Managing Director)



WASSERMANN
DENTAL-MASCHINEN GMBH
Rudorffweg 15 - 17 · 21031 Hamburg



Wassermann Dental-Maschinen GmbH
Rudorffweg 15–17 · 21031 Hamburg · Germany
Phone: +49 (0)40 730 926-20/ -24 · Fax: +49 (0)40 730 37 24
export@wassermann-dental.com · www.wassermann.hamburg



/WassermannDentalmaschinen